

UND-BD Series Diesel Generator Set

Standby
110 kVA
88 kW

Prime
100 kVA
80 kW

Standby Power (ESP): In case of failure of reliable mains supply, variable electricity is used to power the load. ESP complies with ISO8528. Overloading is not allowed.

Prime Power (PRP): Variable electricity to load, power supply, yearly unlimited operation used for the clock. PRP complies with ISO 8528. 12 hours of operation according to ISO3046 Used for 10% overload for 1 hour in the period.



Engine

In Universal Generator engine products; High performance, low fuel consumption, mechanical or electronic governor depending on the type, Oil, air, fuel filters are interchangeable, using high technology engine brands in accordance with ISO 3046, ISO 8528, BS 5514, DIN 6271 standards.

ENGINE SPECIFICATIONS

Engine Brand	BAUDOUIIN	
Engine Model	4M11G120/5	
Engine Power	108 kW / 98 kW (Standby/Prime)	
Speed (rpm)	1500	
Time	4	
Number of Cylinders	4	
Engine Capacity	4,5 lt	
Bore & Stroke (mmXmm)	105x130	
Compression Ratio	18:1	
Governor Type	Electronic	
Induction System	Turbocharge / Intercooler	
Combustion System	Direct	
Cooling System	Water Cooling	
Lubrication Capacity	11 lt	
Coolant Capacity	13 lt	
Fuel Consumption liter/hour	%100	23 lt
	%75	17 lt
	%50	12 lt

Alternator

In Universal Generator alternator products, it has a steel body design, robust structure, maintenance-free bearing system (brushless) with self-excitation system, electronic type voltage regulator, BS 4999-5000; CEI EN 60034-1; IEC 60034-1; VDE 0530, OVE M10, NF 51-100, 111; It uses high technology alternator brands in accordance with NEMA MG 1.22.

ALTERNATOR FEATURES

Power Factor	0,8
Insulation Class	H
Protection	IP21-IP23
Output Voltage	231/400 VAC - 50 Hz
Frequency	50 Hz
Connection Type	Star
Design	4 Poles - Brushless

Control System

Easy-to-use secure software updates in Universal Generator control panels have a structure that can be easily done with USB ports. Optionally, remote control can be provided with ETHERNET and GPRS. Panel body is made of steel sheet and is painted with electrostatic powder paint. It has been painted. The electronics are isolated and waterproof design.

CONTROL SYSTEM FEATURES

LCD Screen Automatic Control System
Remote monitoring possibility
Multifunctional business opportunity
Multi language support
Programmable over USB, RS-232 and GSM



Chassis, Canopy and Fuel Tank

Universal Generator chassis has a modular design and is made of steel. Engine alternator Radiator connections are made with vibration wedges and vibration is minimized. Special chassis and fuel tank in line with customer demands can make designs.

CANOPY

Canopy design that facilitates generator maintenance
Emergency stop button on the cabin
Transparent control cabinet window
Acoustic sponge providing sound insulation
Hidden exhaust silencer inside the cabin
Engine cooling air ducts
Electrostatic powder paint resistant to corrosion and rusting
Refueling outside the cabin

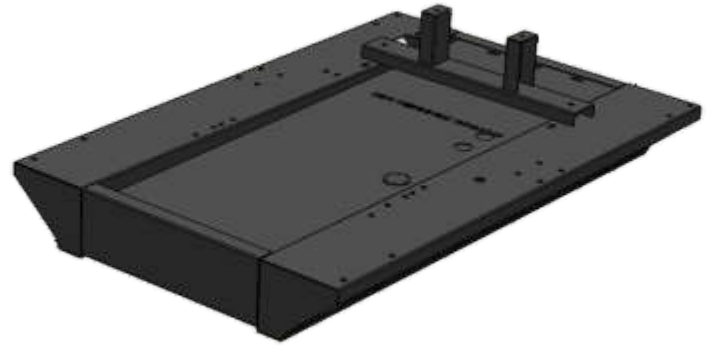

OPTIONS

Transfer Board	Analog Gauges
Protection Switch	24 Hour Fuel Tank
External Type Fuel Tank	Special Chassis Color
Synchronous System	Special Cabinet Color
Electronic Governor Application	Remote Monitoring Module
Earthquake Sensor	Special Type Muffler

Quality Standards

- All generating sets produced by Universal Generator have TSE, CE and ISO 9001 certificates.
- Technical information and values are in accordance with ISO8528, ISO3046, NEMA MG1.22, IEC 600341, BS 49995000, VDE 0530 standards.

TECHNICAL DIMENSIONS

CABINET GROUP

WIDTH	LENGTH	HEIGHT	WEIGHT	FUEL TANK
1100 mm	3100 mm	1690 mm	1922 kg	275 lt

UNCABINET GROUP

WIDTH	LENGTH	HEIGHT	WEIGHT	FUEL TANK
1100 mm	2600 mm	1690 mm	1669 kg	275 lt

